

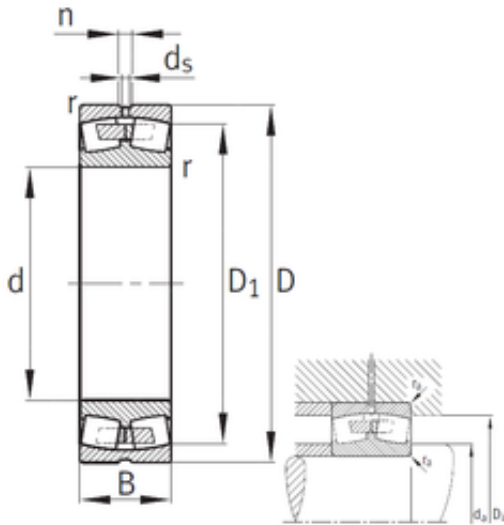

Bearing Import and Export Co., Ltd.



340 mm x 520 mm x 180 mm FAG 24068-B-MB Spherical roller bearings

Bearing No. 24068-B-MB

Size	340x520x180 mm
Bore Diameter	340 mm
Outer Diameter	520 mm
Width	180 mm
d	340 mm
D	520 mm
B	180 mm
C	180 mm
n	17,7 mm
r min.	5 mm
D1	457,1 mm
da min.	358 mm
Da max.	502 mm
ra max.	4 mm
d5	9,5 r/min
Weight	146 Kg
Basic dynamic load rating (C)	3100 kN
Basic static load rating (C0)	6550 kN
Fatigue load limit (Pu)	530
Reference speed	600 r/min
Limiting speed	850 r/min
Calculation factor (e)	0,34
Calculation factor (Y0)	1,93
Calculation factor (Y1)	1,98

24068-B-MB Bearing 2D drawings and 3D CAD models