

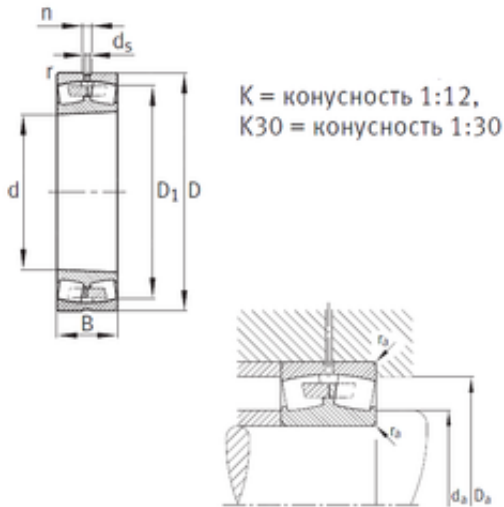

## Bearing Import and Export Co., Ltd.



### 360 mm x 540 mm x 134 mm FAG 23072-K-MB Spherical roller bearings

Bearing No. 23072-K-MB

Size	360x540x134 mm
Bore Diameter	360 mm
Outer Diameter	540 mm
Width	134 mm
d	360 mm
D	540 mm
B	134 mm
C	134 mm
n	23,5 mm
r min.	5 mm
D1	485,2 mm
da min.	378 mm
Da max.	522 mm
ra max.	4 mm
d5	12,5 r/min
Weight	107 Kg
Basic dynamic load rating (C)	2450 kN
Basic static load rating (C0)	4800 kN
Fatigue load limit (Pu)	295
Reference speed	790 r/min
Limiting speed	950 r/min
Calculation factor (e)	0,25
Calculation factor (Y0)	2,68
Calculation factor (Y1)	2,74

23072-K-MB Bearing 2D drawings and 3D CAD models