

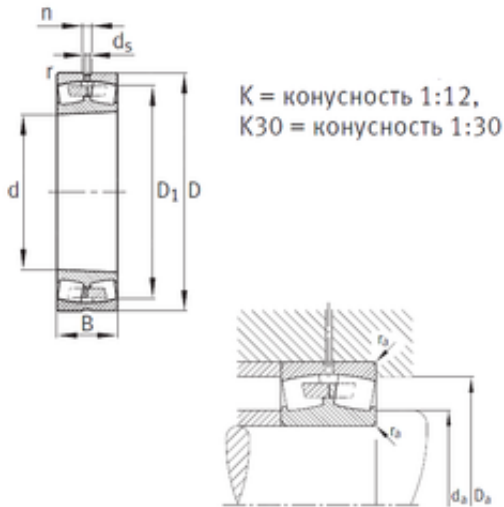

Bearing Import and Export Co., Ltd.



360 mm x 650 mm x 232 mm FAG 23272-B-K-MB Spherical roller bearings

Bearing No. 23272-B-K-MB

23272-B-K-MB Bearing 2D drawings and 3D CAD models

Size	360x650x232 mm
Bore Diameter	360 mm
Outer Diameter	650 mm
Width	232 mm
d	360 mm
D	650 mm
B	232 mm
C	232 mm
n	23,5 mm
r min.	6 mm
D1	548,3 mm
da min.	386 mm
Da max.	624 mm
ra max.	5 mm
d5	12,5 r/min
Weight	328 Kg
Basic dynamic load rating (C)	4900 kN
Basic static load rating (C0)	9150 kN
Fatigue load limit (Pu)	720
Reference speed	425 r/min
Limiting speed	800 r/min
Calculation factor (e)	0,38
Calculation factor (Y0)	1,74
Calculation factor (Y1)	1,78