

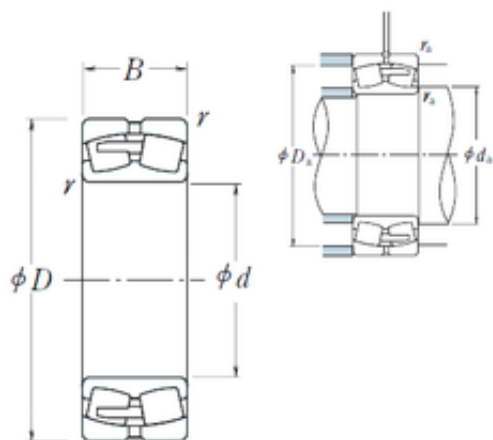

Bearing Import and Export Co., Ltd.

230/710CAE4 NSK Spherical Roller Bearing



Bearing No. 230/710CAE4

Size	710x1030x236 mm
Bore Diameter	710 mm
Outer Diameter	1030 mm
Width	236 mm
d	710 mm
D	1030 mm
B	236 mm
C	236 mm
r min.	7,5 mm
da min.	746 mm
Da min	936 mm
Da max.	994 mm
ra max.	6 mm
Weight	647 Kg
Basic dynamic load rating (C)	7100 kN
Basic static load rating (C0)	15800 kN
(Grease) Lubrication Speed	240 r/min
(Oil) Lubrication Speed	280 r/min
Calculation factor (e)	0,22
Calculation factor (Y0)	3
Calculation factor (Y2)	4,6

230/710CAE4 Bearing 2D drawings and 3D CAD models