

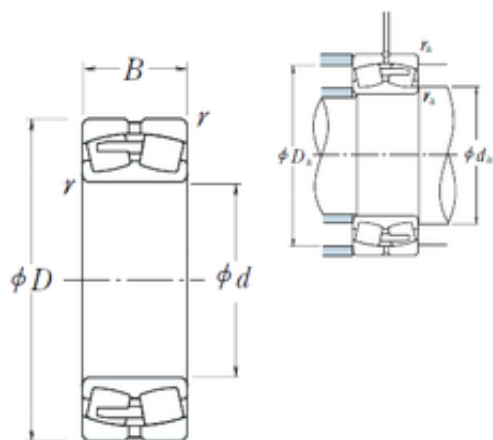

Bearing Import and Export Co., Ltd.

239/950CAE4 NSK Spherical Roller Bearing



Bearing No. 239/950CAE4

Size	950x1250x224 mm
Bore Diameter	950 mm
Outer Diameter	1250 mm
Width	224 mm
d	950 mm
D	1250 mm
B	224 mm
C	224 mm
r min.	7,5 mm
da min.	986 mm
Da min	1169 mm
Da max.	1214 mm
ra max.	6 mm
Weight	732 Kg
Basic dynamic load rating (C)	7600 kN
Basic static load rating (C0)	19900 kN
(Grease) Lubrication Speed	160 r/min
(Oil) Lubrication Speed	200 r/min
Calculation factor (e)	0,16
Calculation factor (Y0)	4,1
Calculation factor (Y2)	6,3

239/950CAE4 Bearing 2D drawings and 3D CAD models